

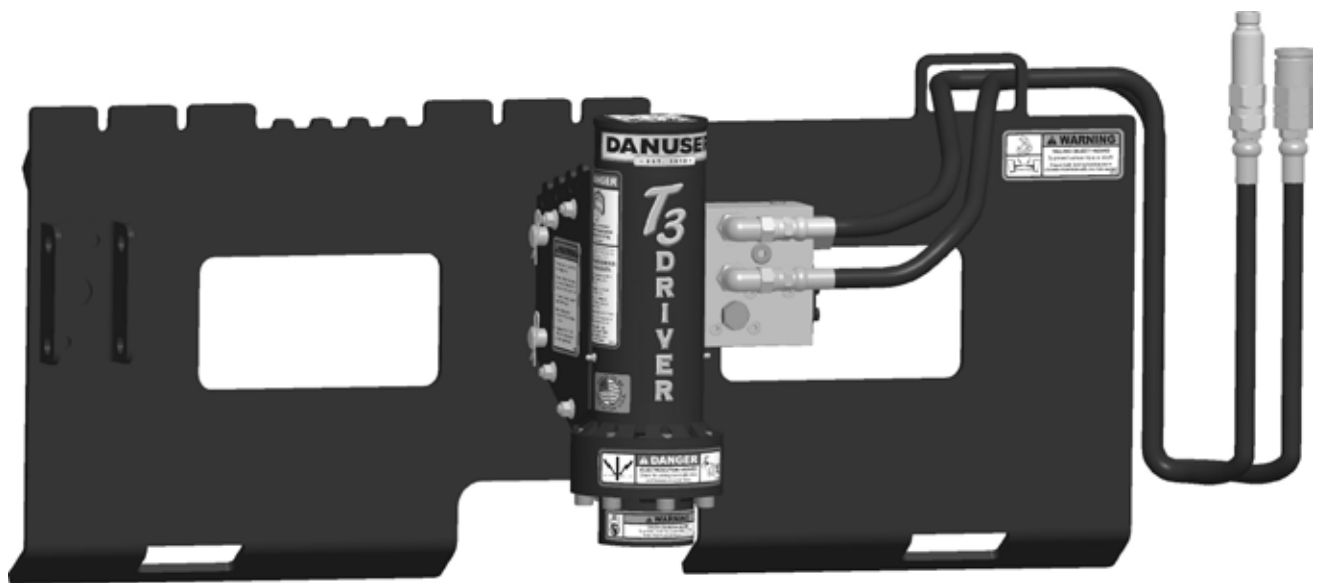



T3 DRIVER



 **Read this entire manual. This safety alert symbol is used throughout this manual to call your attention to messages involving your personal safety and the safety of others. Failure to follow these instructions can result in injury or death.**

WARNING

Si no entiende ingles, se prefiere que busque a alguien que interprete las instrucciones para usted.

Owner: _____
Date Purchased: _____
Model #: _____ Serial #: _____
Manual #: <u>9MT32458378</u>

Operator's Manual

Danuser LLC
500 E. 3rd St.
P.O. Box 368
Fulton, MO 65251
Tel: (573) 642-2246 Fax: (573) 642-2240
E-mail: sales@danuser.com
Website: www.danuser.com



Dear Owner/Operator,

Thank you for purchasing this Danuser T3 Driver. We appreciate your business.

Designed for T-Posts, the T3 can drive up to 3" O.D. pipe. Eliminate the fatigue often associated with hand-held drivers.

Your safety as an operator of our product is very important to us. Therefore, *before* you assemble, install, operate, maintain, service, remove, or move your Danuser T3 Driver, read and understand this manual thoroughly. If there is anything you do not understand, immediately contact your dealer, or contact our factory direct.

Phone:	(573) 642-2246
Fax:	(573) 642-2240
E-mail:	sales@danuser.com

Your satisfaction in the performance and longevity of our product is also very important to us and can be prolonged by proper assembly, installation, operation, and maintenance as instructed in this manual.

Thank you again for your business and for your trust in our product. Please feel free to contact us at any time for further assistance.

Sincerely,

Danuser LLC
500 E. 3rd St.
P.O. Box 368
Fulton, MO 65251

Tel: (573) 642-2246 Fax: (573) 642-2240
E-mail: sales@danuser.com Website: www.danuser.com

Danuser provides this manual "as is" without warranty of any kind, either expressed or implied. Danuser assumes no responsibility for errors or omissions. Danuser assumes no liability for damages resulting from the use of the information contained herein. Danuser reserves the right to revise and improve its products as it sees fit. This manual describes the state of this product at the time of its publication and may not reflect the product in the future.

Danuser is a registered trademark.

Foreword

Please read this manual thoroughly!

Before you assemble, install, operate, maintain, service, remove, or move your Danuser T3 Driver, read this manual thoroughly. If there is anything you do not understand, immediately contact your dealer, or call our factory direct at (573) 642-2246. Powered equipment can be dangerous if not assembled, installed, operated, maintained, serviced, removed, or moved properly.

Warranty Registration

To activate your warranty coverage and to provide you with efficient customer service, please fill out your WARRANTY REGISTRATION FORM. This form is included in your unit's paperwork package. If you did not complete a WARRANTY REGISTRATION FORM or did not receive one, please call Danuser LLC. Or, register online at www.Danuser.com. Your satisfaction with our product and your safety as a user of our product are both very important to us.

Symbols

 This SAFETY ALERT symbol identifies important safety messages. Carefully read each safety message that follows. Failure to understand and obey a safety message, or recognize a safety hazard, could result in injury or death to you or others around you. The operator is ultimately responsible for the safety of himself, as well as others, in the operating area of the T3 Driver.





<i>Symbol</i>	<i>Meaning</i>
	Indicates an imminently hazardous situation which, if not avoided, will result in death or serious injury.
	Indicates a potentially hazardous situation which, if not avoided, could result in death or serious injury, including hazards that are exposed when guards are removed.
	Indicates a potentially hazardous situation which, if not avoided, may result in minor or moderate injury. It may also be used to alert against unsafe practices.
	This is important information for proper use of this equipment. Failure to comply may lead to premature equipment failure.

Table of Contents

	Page
Letter to the Owner/Operator	2
Foreword	3
Symbols	3
Safety	4
Decals & Safety Signs	7
Specifications	9
Hydraulic Requirements	10
Assembly & Installation	11
Operation	14
Removal & Storage	15
Troubleshooting	15
Maintenance & Lubrication	16
Torque Values Chart	17
Parts	18
Accessories	20
Warranty	Form No. 3412

WARNING

Working with unfamiliar equipment can lead to careless injuries. Read and understand this manual and the manual for your vehicle before assembling, installing, operating, maintaining, servicing, removing, or moving this T3 Driver. If there is anything in this manual you do not understand, contact your dealer or Danuser LLC. The safe use of this attachment is strictly up to you, the operator. If this attachment is used, loaned, or rented by any other person, it is the owner's responsibility to make certain that the operator prior to operating:

- Reads and understands the Operator's Manuals
 - Is instructed in safe and proper use
- The T3 Driver is designed to be operated from the vehicle seat. Keep bystanders away from the work area. Do not operate with another person in contact with any part of the T3 Driver.
 - All operators of this attachment must read and understand this entire manual, paying particular attention to safety messages and operation instructions, prior to assembling, installing, operating, maintaining, servicing, removing, or moving the T3 Driver.
 - Please remember it is also important that you read, understand, and follow safety signs on the attachment. Clean or replace all safety signs if they cannot be clearly read and understood. They are there for your safety as well as the safety of others. Danuser LLC will furnish new safety signs upon request at no charge.
 - All things with moving parts are potentially hazardous. There is no substitute for a cautious, safe-minded operator who recognizes potential hazards and follows reasonable safety practices.
 - Personal protection equipment including hard hat, safety glasses, safety shoes, gloves, and ear plugs are recommended during assembly, installation, operation, maintenance, service, removal, or movement of the attachment.
 - When the use of hand tools is required to perform any part of assembly, installation, operation, maintenance, or service of the attachment, be sure the tools used are designed and recommended by the tool manufacturer for that specific task.
 - Never check pressurized system for leaks with your bare hand. Wear proper hand and eye protection and use wood or cardboard when searching for suspected leaks. Oil escaping from pinhole leaks under pressure can penetrate skin and create a serious medical emergency. If any fluid is injected into the skin, gangrene, blood poisoning, even death may result. Obtain medical attention immediately.
 - Always use two people to handle heavy, unwieldy components during assembly, installation, maintenance, service, removal, or movement of the attachment.
 - Never place any part of your body where it would be in danger if movement should occur during assembly, installation, operation, maintenance, service, removal, or movement of the T3 Driver.
 - Only properly trained people should operate this equipment. Do not allow anyone who has not read this entire manual and understands the safety rules, safety signs, and operation instructions to use this attachment.
 - Never allow children to operate or be around the T3 Driver.
 - Do not allow riders on the equipment at any time. There is no safe place for any riders.
 - Never use alcoholic beverages or drugs which can hinder alertness or coordination while operating this equipment. Consult your doctor about operating this equipment while taking prescription or over-the-counter medications.

Safety

(continued)

- Safe operation of equipment requires the operator's full attention. Avoid distractions such as radio headphones, cell phones, etc. while operating.
- Contact with underground gas lines or electrical cables may result in serious injury or death from explosion or electrical shock. Before operating, call 811 or the local number to locate underground utilities.
- Do not drive posts near underground utility lines.
- Stay away from power lines when transporting, raising, or operating the attachment. Electrocutation can occur without direct contact.
- The T3 Driver must be securely latched to the vehicle. Ensure both locking handles are in the locked position with pins fully seated. An improperly latched T3 Driver can fall without warning.
- Before you operate the attachment, check over pins and connections to be sure all are securely in place.
- Keep hands, feet, hair, jewelry, and clothing away from all moving and/or rotating parts.
- Never place yourself between the vehicle and the attachment.
- Never allow anyone under the attachment at any time.
- Keep clear of the T3 Driver while in operation. Never position, align, or support the post by hand or with any tool when the T3 Driver is in operation.
- Do not exceed the vehicle's rated operating load. Use sufficient counterweights. Move the vehicle slowly when the attachment is raised.
- Carry the load low. A heavy load can cause instability of the vehicle. Use extreme care during travel. Slow down on turns and watch out for bumps. Use all safety devices, including a seat belt, as recommended in the vehicle operator's manual.
- Do not operate the T3 Driver on steep hillsides. When operating the T3 Driver on uneven or hilly terrain, position the vehicle with the attachment uphill. With the attachment downhill, the vehicle could tip when attempting to raise the T3 Driver. Consult your vehicle operator's manual for maximum incline allowable.
- Always shut off the vehicle engine, remove the key, lower vehicle arms, and relieve all hydraulic pressure before dismounting the vehicle. Never leave equipment unattended with the vehicle running.
- Never attempt adjustments, service, or repairs while the equipment is in operation.
- Never work under equipment supported by hydraulics. Even with the vehicle shut off, equipment can suddenly drop if controls are actuated or if hydraulic lines burst.
- Before disconnecting hydraulic lines or fittings, be sure to relieve all pressure by cycling all hydraulic controls after shutdown. Remember hydraulic systems are under pressure whenever the engine is running and may hold pressure after shutdown.
- Store the attachment on a flat, level surface in an area where children do not play. Securely block and support the attachment.
- Do not modify the attachment. Modifications may weaken the integrity of the attachment and may impair the safety, function, life, and performance of the T3 Driver.
- When making repairs or servicing the T3 Driver, use only parts that meet original equipment manufacturer's standards and requirements.

Safety

(continued)

- Always use care when operating the T3 Driver. Most accidents occur because of neglect or carelessness.

Safety is a primary concern in the design, manufacture, sale, and use of T3 Drivers. Danuser confirms to you, our customer, our concern for safety.

DANGER

Improper operation of this T3 Driver can cause serious personal injury or death. Operation of this attachment should only be done by a competent adult acting in compliance with the Operator's Manual. Since T3 Driver operations are beyond our control, we disclaim all liability for any damages, injuries, or death which may result.

WARNING

This product can expose you to chemicals known to the State of California to cause cancer and birth defects or other reproductive harm. For more information go to www.P65Warnings.ca.gov/product.

Decals & Safety Signs

Skid-Steer

The T3 Driver comes equipped with all safety signs in place. Their locations are shown in this section. Read and follow their instructions and ensure their care:

- Keep safety signs clean and legible at all times.
- Replace safety signs that are missing, illegible, or damaged.
- Ensure replacement parts installed during repair have safety signs attached.

To install new safety signs, follow these steps:

1. Clean the area where the safety sign is to be placed.
2. Spray a little soapy water on the surface where the safety sign is to be placed.
3. Peel the backing from the safety sign, and apply it in the position shown.
4. Firmly press the safety sign, and squeeze out the air bubbles with a straight edge (e.g., a credit card).

PART NO. 20673
Location: Unit, top

PART NO. DIG5
Location: Unit, top

PART NO. CA65
Location: Unit, back

PART NO. DANUSER103
Location: Unit, front

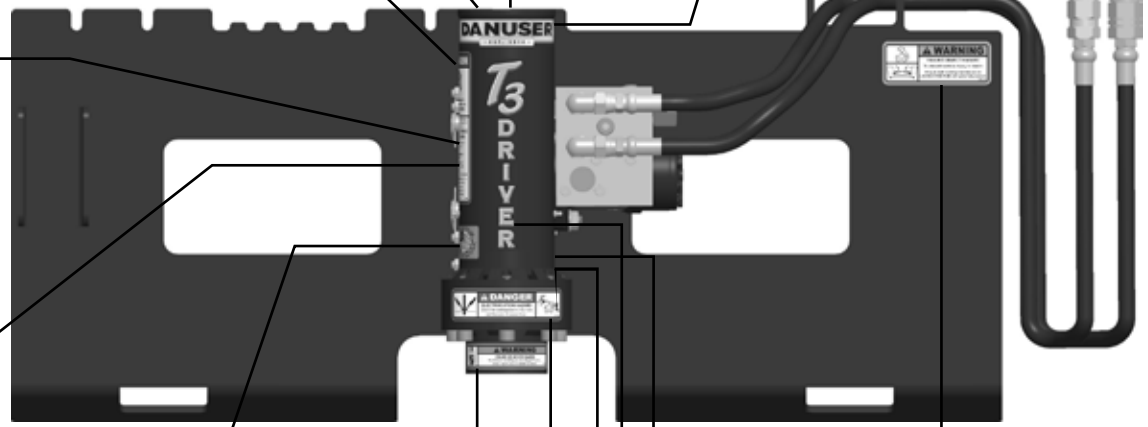

PART NO. DIG14
Location: Unit, right side



PART NO. 9875
Location: Unit, right side

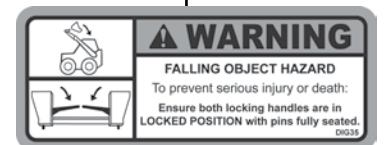

PART NO. DIG35
Location: Quick attach plate, front



PART NO. DIG32
Location: Unit, front



Model No. & Serial No.
Location: Unit, left side

PART NO. DIG13
Location: Unit, right side



PART NO. DIG31
Location: Unit, front

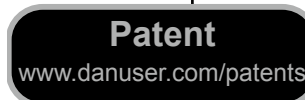

PART NO. 20658
Location: Unit, top

PART NO. 21282
Location: Unit, front



Clean or replace all safety signs if they cannot be clearly read and understood.

T3 DRIVER

Decals & Safety Signs

(continued)

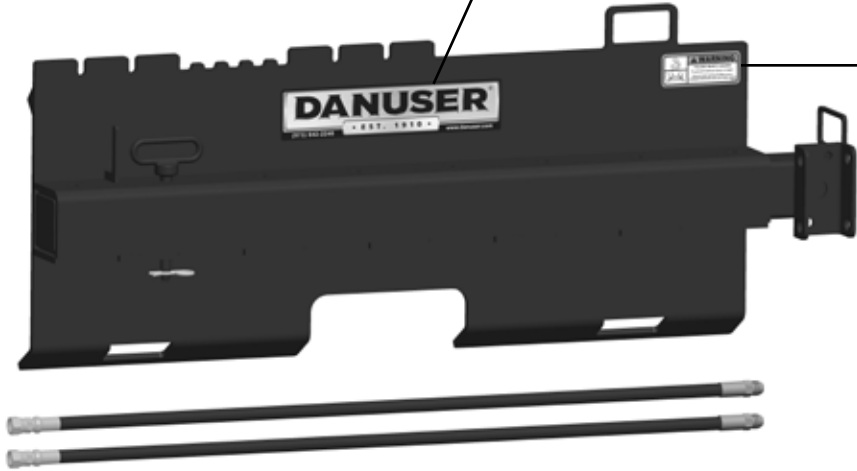

Skid-Steer Offset Quick Attach Mount

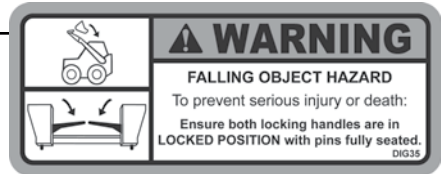

PART NO. DIG35
Location: Quick attach plate, front



Euro/Global Offset Quick Attach Mount

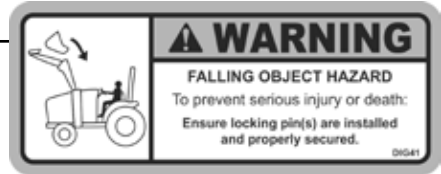

PART NO. DIG41
Location: Quick attach plate, top



John Deere 200/300/400/500 Series Quick Attach Mount

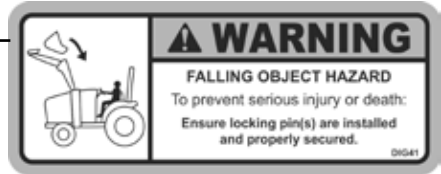

PART NO. DIG41
Location: Quick attach plate, top

WARNING

Clean or replace all safety signs if they cannot be clearly read and understood.

Specifications

Operator's Manual
Direction Terminology

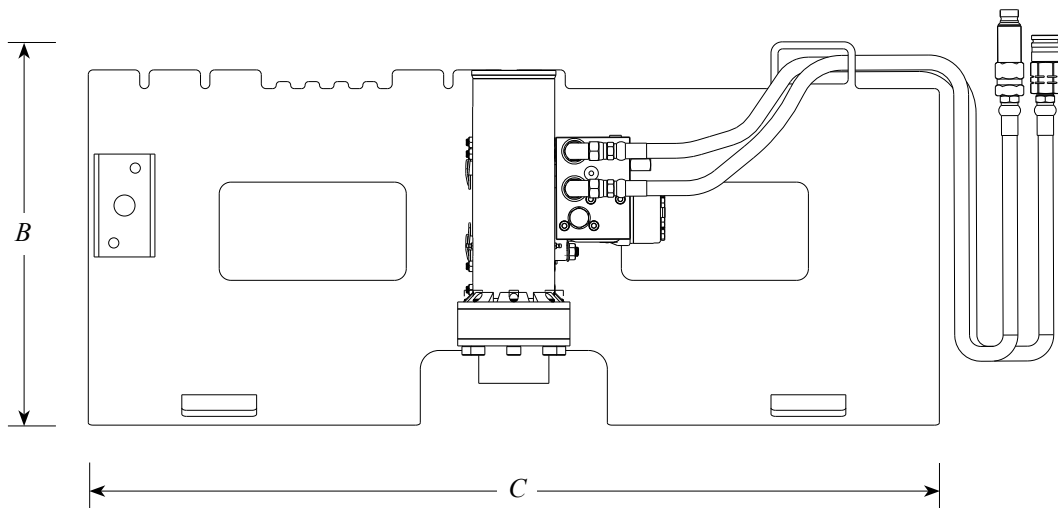
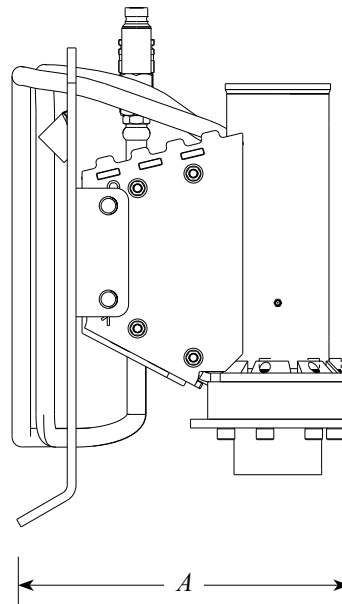
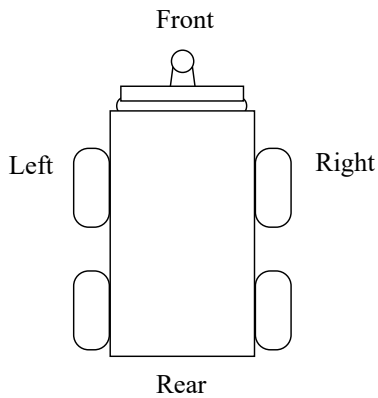

T3 Driver	Skid-Steer	Skid-Steer Offset	Euro/Global	John Deere
Overall Length (A)	14"	18"	16"	15"
Overall Height (B)	19"	19"	21"	24"
Overall Width (C)	45.5"	Extendable 50.5"-86.5"	45"	49"
Hammer Weight	10 lbs.			
Max. Hits Per Second	6			
Hydraulic Requirements	1500-3000 PSI Up to 30 GPM			
Maximum Post Size	3" O.D. pipe			
Impact Force	2000 lbs.			
Impact Energy	40 ft.-lbs.			

Hydraulic Requirements

Filtration Requirements:

- A filter of, at least, 10 micron filtration is required.

NOTE

The life of the hydraulic componentry is almost entirely dependent upon cleanliness of the oil. Instructions in your vehicle operator's manual regarding filter and oil changes should be carefully followed. Even small amounts of dirt in the hydraulic oil can cause premature hydraulic componentry failure that is not covered by warranty.

Pressure and Flow Requirements:

- The T3 Driver is designed to operate up to 30 GPM and 1500-3000 PSI.
- The driver is equipped with a hydraulic manifold with a flow regulator set at 15 GPM. The T3 performs at maximum efficiency (6 strokes per second) at 15 GPM. The unit is functional at a lower GPM but will operate with fewer strokes per second.

Hydraulic Fluid Selection Requirements:

- Premium grade petroleum based fluids will provide the best performance.
- Fluids that contain anti-wear agents, rust inhibitors, anti-foaming agents, and oxidation inhibitors are recommended.
- The viscosity of the fluid should never fall below 70 SUS (13 cST). The best viscosity range for the T3 Driver is 100-200 SUS (20-43 cST).

Assembly & Installation

Mount Bracket

⚠️ WARNING

Personal protection equipment including hard hat, safety glasses, safety shoes, gloves, and ear plugs are recommended during assembly, installation, operation, maintenance, service, removal, or movement of the attachment.

⚠️ CAUTION

Always use two people to handle heavy, unwieldy components during assembly, installation, maintenance, service, removal, or movement of the attachment.

REF. NO.	PART NO.	DESCRIPTION	QTY.
1	21302	Mount Bracket	1
2	21284	Pin	2
3	21078	Rue Clip	4

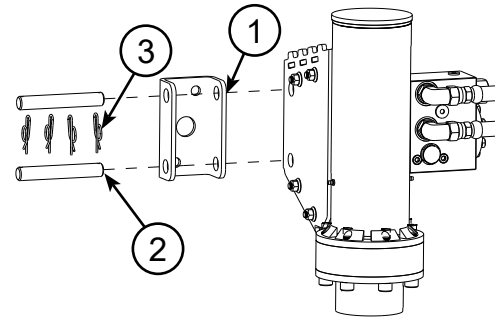

NOTE

Consideration must be given to the installation location of the bolt-on bracket. The flat mounting surface must be constructed with sufficient strength to safely handle the loads generated during the operation of the T3 Driver. Make sure to position the driver to allow space for the hydraulic hose connections and routing of the hoses.

Option 1: Bolt on

- STEP 1: Drill two holes in the desired surface to accommodate the mount bracket (1).
- STEP 2: Bolt mount bracket to desired location using the following hardware (not included):
- 2 bolts (1/2" diameter, Grade 5 or greater)
 - 2 lock washers (1/2")
 - 2 nuts (1/2")

Proceed to step 2 below.

Option 2: Weld on

- STEP 1: Weld all around the mounting bracket and plug weld the bolt holes to the desired mounting surface, making sure to leave room for the driver to be mounted on the bracket.
- STEP 2: Attach the T3 Driver unit to the bracket using the two pins (2) and the four rue clips (3).
- STEP 3: Connect the hydraulic hoses to the vehicle's auxiliary hydraulic outlets. Test the vehicle to make sure you have enough hose length to perform the full range of the loader arms' operating heights.

⚠️ WARNING

Before connecting or disconnecting hydraulic lines or fittings, be sure to relieve all pressure by cycling all hydraulic controls after shutdown. Remember hydraulic systems are under pressure whenever the engine is running and may hold pressure after shutdown.

NOTE

Ensure quick couplers are clean prior to connection.

NOTE

Hose routing is the responsibility of the operator. Pinched and/or stretched hoses are not covered under the warranty.

- STEP 4: With the vehicle engine shut off, grease all zerks.
- STEP 5: Start the vehicle. Engage the auxiliary hydraulics.

Assembly & Installation

(continued)

Assembly & Installation

Quick Attach Plate

WARNING

Personal protection equipment including hard hat, safety glasses, safety shoes, gloves, and ear plugs are recommended during assembly, installation, operation, maintenance, service, removal, or movement of the attachment.

CAUTION

Always use two people to handle heavy, unwieldy components during assembly, installation, maintenance, service, removal, or movement of the attachment.

STEP 6: Check the hydraulic system for leaks.

WARNING

Never check pressurized system for leaks with your bare hand. Wear proper hand and eye protection and use wood or cardboard when searching for suspected leaks. Oil escaping from pinhole leaks under pressure can penetrate skin and create a serious medical emergency. If any fluid is injected into the skin, gangrene, blood poisoning, even death may result. Obtain medical attention immediately.

Prepare the Vehicle

Read and understand the manual for your vehicle before assembling or installing the T3 Driver. The vehicle must be equipped with either a skid-steer quick attach hitch, Euro/Global quick attach hitch, or John Deere 200/300/400/500 Series quick attach hitch and auxiliary hydraulics.

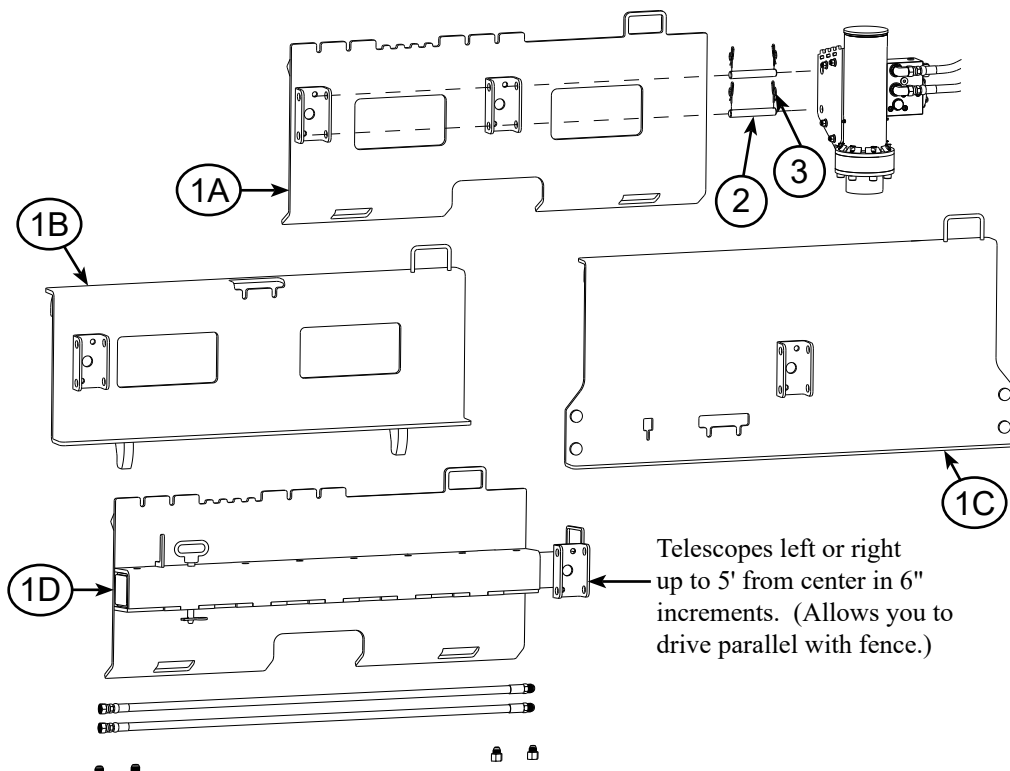

REF. NO.	PART NO.	DESCRIPTION	QTY.
1A	21305	Skid-Steer Quick Attach Mount	1
1B	21303	Euro/Global Offset Quick Attach Mount	
1C	21304	John Deere 200/300/400/500 Series Quick Attach Mount	
1D	21355	Skid-Steer Offset Quick Attach Mount (Includes Hoses and Adapters)	
2	21284	Pin	2
3	21078	Rue Clip	4

STEP 1: Park the vehicle on level ground, and install the quick attach plate by following your vehicle operator's manual for installing an attachment.

WARNING

The quick attach plate must be securely latched to the vehicle. Ensure both locking pins are fully seated. An improperly latched quick attach plate can fall without warning.

Assembly & Installation

(continued)

- STEP 2: Attach the T3 Driver to either of the brackets on the plate using the two pins (2) and the four rue clips (3).
- STEP 3: Route the hydraulic hoses through the quick attach plate hose holder.
- STEP 4: Connect the hydraulic hoses to the vehicle's auxiliary hydraulic outlets. Test the vehicle to make sure you have enough hose length to perform the full range of the loader arms' operating heights.

⚠ WARNING

Before connecting or disconnecting hydraulic lines or fittings, be sure to relieve all pressure by cycling all hydraulic controls after shutdown. Remember hydraulic systems are under pressure whenever the engine is running and may hold pressure after shutdown.

NOTE Ensure quick couplers are clean prior to connection.

NOTE Hose routing is the responsibility of the operator. Pinched and/or stretched hoses are not covered under the warranty.

- STEP 5: With the vehicle engine shut off, grease all zerks.
- STEP 6: Engage the auxiliary hydraulics.
- STEP 7: Check the hydraulic system for leaks.

⚠ WARNING

Never check pressurized system for leaks with your bare hand. Wear proper hand and eye protection and use wood or cardboard when searching for suspected leaks. Oil escaping from pinhole leaks under pressure can penetrate skin and create a serious medical emergency. If any fluid is injected into the skin, gangrene, blood poisoning, even death may result. Obtain medical attention immediately.

Tilt Option

If you purchased the optional tilt bracket for the T3 Driver, follow the instructions below.

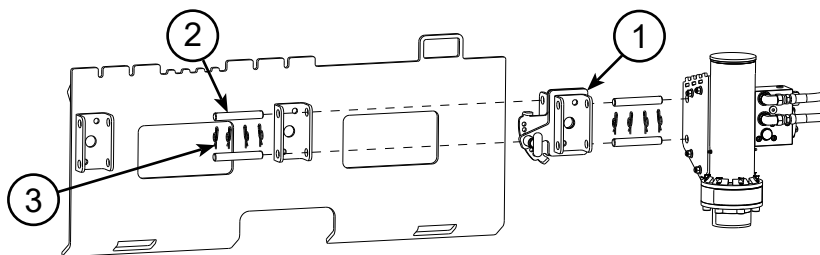

REF. NO.	PART NO.	DESCRIPTION	QTY.
1	21301	Tilt Bracket	1
2	21284	Pin	2
3	21078	Rue Clip	4

- STEP 1: Attach the T3 Driver unit to the tilt bracket (1) using the existing two pins and the four rue clips.

NOTE The tilt bracket handle should be oriented on the opposite side of the motor and manifold for easier access.

Assembly & Installation

(continued)

Operation

DANGER

The T3 Driver is designed to be operated from the vehicle seat. Keep bystanders away from the work area. Do not operate with another person in contact with any part of the T3 Driver.

WARNING

Personal protection equipment including hard hat, safety glasses, safety shoes, gloves, and ear plugs are recommended during assembly, installation, operation, maintenance, service, removal, or movement of the attachment.

WARNING

Safe operation of equipment requires the operator's full attention. Avoid distractions such as radio headphones, cell phones, etc. while operating.

DANGER

Do not allow riders on the equipment at any time. There is no safe place for any riders.

STEP 2: Attach the T3 with tilt bracket to the quick attach plate using the two pins (2) and four ruc clips (3) that were supplied with the tilt bracket.

STEP 3: Route the hydraulic hoses through the quick attach plate hose holder.

STEP 4: Connect the hydraulic hoses to the vehicle's auxiliary hydraulic outlets. Test the vehicle to make sure you have enough hose length to perform the full range of the loader arms' operating heights.

NOTE

To use the T3 Driver tilt bracket, pull out on the black T-Handle pin and adjust it to the appropriate angle. The T-Handle can be pushed in and locked, or you can use the lock out option for floating tilt operation.

DANGER

Contact with underground gas lines or electrical cables may result in serious injury or death from explosion or electrical shock. Before operating, call 811 or the local number to locate underground utilities. Do not drive posts near underground utility lines.

DANGER

Stay away from power lines when transporting, raising, or operating the attachment. Electrocution can occur without direct contact.

WARNING

Before you operate the attachment, check over pins and connections to be sure all are securely in place. Make sure the T3 Driver is securely latched to the vehicle.

STEP 1: The T3 Driver requires a second person to position the post. This person will set the post at the desired location and grasp the post securely, making sure their hands are at least 30 inches (30") from the top of the post.

DANGER

When using a second person, do not turn on the auxiliary hydraulics until the second person is clear from the work area.

STEP 2: Once the post is in position, raise the T3 Driver above the post, tilting slightly forward to see the opening of the driver. Tilt back and lower the driver onto the post until it's fully loaded inside the driver.

DANGER

After the post is in position, the second person must move away from the T3 Driver and vehicle.

STEP 2: After the second person has cleared the area, place the loader arms in the float position. If the vehicle is not equipped with float, the loader arms should be lowered, applying down force to the post.

STEP 3: Move the vehicle slowly left, right, forward, or backward as needed until the post appears vertical to the ground.

Operation

(continued)

Removal & Storage

DANGER

Never allow anyone under the attachment at any time.

WARNING

Personal protection equipment including hard hat, safety glasses, safety shoes, gloves, and ear plugs are recommended during assembly, installation, operation, maintenance, service, removal, or movement of the attachment.

CAUTION

Always use two people to handle heavy, unwieldy components during assembly, installation, maintenance, service, removal, or movement of the attachment.

Troubleshooting

STEP 4: With the machine at idle, cycle the hydraulics to activate the T3 Driver. (It will only work in one direction.) Increase engine RPM until driver is at desired speed.

STEP 5: Drive the post to the desired depth.

STEP 6: As soon as the weight is released, shut off hydraulics, raise the T3 until the post is cleared, and move to the next post.

Before storage, the T3 Driver should be thoroughly cleaned, washing off all dirt and grime. Make sure the hydraulic system is properly sealed against contaminants entering the unit. Always store the T3 Driver in a dry, covered location.

STEP 1: Lower the T3 onto a flat, level surface in an area where children do not play.

STEP 2: Disconnect the hydraulic hoses from the vehicle's auxiliary hydraulics.

WARNING

Before disconnecting hydraulic lines or fittings, be sure to relieve all pressure by cycling all hydraulic controls after shutdown. Remember hydraulic systems are under pressure whenever the engine is running and may hold pressure after shutdown.

NOTE

Connect the quick couplers together to prevent contaminants from entering the T3's hydraulic system.

STEP 3: Follow your vehicle operator's manual for removing an attachment. Securely block and support the attachment.

STEP 4: Tighten any loose nuts, bolts, and hydraulic components.

STEP 5: Replace any damaged or missing safety signs.

STEP 6: Lubricate the grease zerks.

Problem	Possible Cause	Solution
Driver will not operate	Motor damaged	Contact Danuser.
	Incorrect hose routing	Refer to the Parts section of manual for proper hose routing.
	No post loaded in driver	A post must be pushed up inside the driver until it stops before the machine will cycle.
	Housing is not lubricated	Grease the housing.
Oil over heating	Low oil level	Fill reservoir to proper level.
	Dirty oil or oil filter	Change oil and filter.

For additional assistance, please call your dealer or contact Danuser direct:

Tel: (573) 642-2246

Fax: (573) 642-2240

E-mail: sales@danuser.com

Maintenance & Lubrication

Proper servicing and maintenance are key to the long life of any attachment. Careful inspection and routine maintenance helps avoid costly downtime and repair. Do not use the T3 Driver with any damaged parts.

⚠ DANGER

Never allow anyone under the attachment at any time.

⚠ WARNING

Personal protection equipment including hard hat, safety glasses, safety shoes, gloves, and ear plugs are recommended during assembly, installation, operation, maintenance, service, removal, or movement of the attachment.

⚠ WARNING

Never check pressurized system for leaks with your bare hand. Wear proper hand and eye protection and use wood or cardboard when searching for suspected leaks. Oil escaping from pinhole leaks under pressure can penetrate skin and create a serious medical emergency. If any fluid is injected into the skin, gangrene, blood poisoning, even death may result. Obtain medical attention immediately.

⚠ WARNING

Do not modify the attachment. Modifications may weaken the integrity of the attachment and may impair the safety, function, life, and performance of the T3 Driver.

⚠ CAUTION

When making repairs or servicing the T3 Driver, use only parts that meet original equipment manufacturer's standards and requirements.

Maintenance	Interval
Inspect the attachment for any damage, worn parts, or cracked welds. Repair or replace as necessary.	Before each use
Check for damaged or missing safety signs. Replace as necessary.	Before each use
Check all fasteners. Ensure they are tight and secure. (See Torque Values Chart.) Replace as necessary.	Daily
Check all hydraulic components for leaks or wear. Repair or replace as necessary.	Daily

Lubrication Points

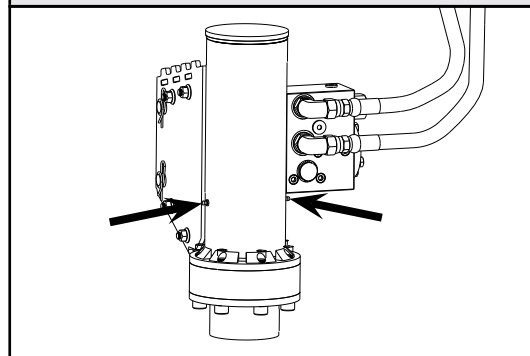

Left & Right Sides of Unit - 2 Zerks

Add multi-purpose grease

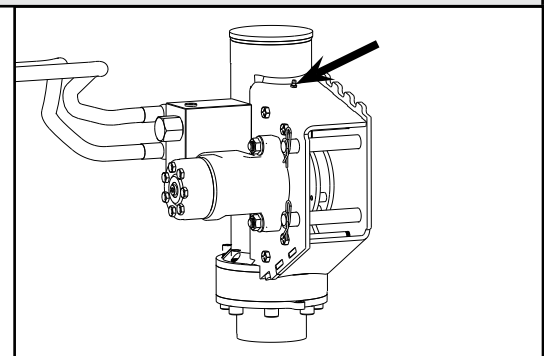
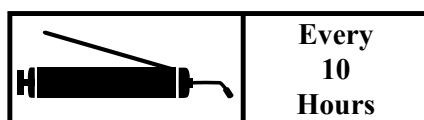





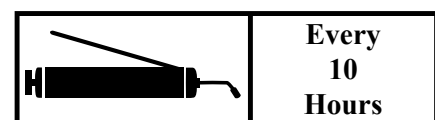

Top Back Side of Unit - 1 Zerk

Add multi-purpose grease



Torque Values Chart

Torque Values Chart													
Bolt Size (inches)	Bolt Head Identification						Bolt Size (Metric)	Bolt Head Identification					
	 Grade 2		 Grade 5		 Grade 8			 Class 5.8		 Class 8.8		 Class 10.9	
in-tpi	Nm	ft.-lbs.	Nm	ft.-lbs.	Nm	ft.-lbs.	mm x pitch	Nm	ft.-lbs.	Nm	ft.-lbs.	Nm	ft.-lbs.
1/4"-20	7.4	5.6	11	8	16	12	M5 x 0.8	4	3	6	5	9	7
1/4"-28	8.5	6	13	10	18	14	M6 x 1	7	5	11	8	15	11
5/16"-18	15	11	24	17	33	25	M8 x 1.25	17	12	26	19	36	27
5/16"-24	17	13	26	19	37	27	M8 x 1	18	13	28	21	39	29
3/8"-16	27	20	42	31	59	44	M10 x 1.5	33	24	52	39	72	53
3/8"-24	31	22	47	35	67	49	M10 x 0.75	39	29	61	45	85	62
7/16"-14	43	32	67	49	95	70	M12 x 1.75	58	42	91	67	125	93
7/16"-20	49	36	75	55	105	78	M12 x 1.5	60	44	95	70	130	97
1/2"-13	66	49	105	76	145	105	M12 x 1	90	66	105	77	145	105
1/2"-20	75	55	115	85	165	120	M14 x 2	92	68	145	105	200	150
9/16"-12	95	70	150	110	210	155	M14 x 1.5	99	73	155	115	215	160
9/16"-18	105	79	165	120	235	170	M16 x 2	145	105	225	165	315	230
5/8"-11	130	97	205	150	285	210	M16 x 1.5	155	115	240	180	335	245
5/8"-18	150	110	230	170	325	240	M18 x 2.5	195	145	310	230	405	300
3/4"-10	235	170	360	265	510	375	M18 x 1.5	220	165	350	260	485	355
3/4"-16	260	190	405	295	570	420	M20 x 2.5	280	205	440	325	610	450
7/8"-9	225	165	585	430	820	605	M20 x 1.5	310	230	650	480	900	665
7/8"-14	250	185	640	475	905	670	M24 x 3	480	355	760	560	1050	780
1"-8	340	250	875	645	1230	910	M24 x 2	525	390	830	610	1150	845
1"-12	370	275	955	705	1350	995	M30 x 3.5	960	705	1510	1120	2100	1550
1-1/8"-7	480	355	1080	795	1750	1290	M30 x 2	1060	785	1680	1240	2320	1710
1-1/8"-12	540	395	1210	890	1960	1440	M36 x 3.5	1730	1270	2650	1950	3660	2700
1-1/4"-7	680	500	1520	1120	2460	1820	M36 x 2	1880	1380	2960	2190	4100	3220
1-1/4"-12	750	555	1680	1240	2730	2010	<p align="center">KEY:</p> <p>in-tpi = nominal thread diameter in inches-threads per inch Nm = Newton-meter ft.-lbs. = foot pounds mm x pitch = nominal thread diameter in millimeters by thread pitch</p>						
1-3/8"-6	890	655	1990	1470	3230	2380							
1-3/8"-12	1010	745	2270	1670	3680	2710							
1-1/2"-6	1180	870	2640	1950	4290	3160							
1-1/2"-12	1330	980	2970	2190	4820	3560							

Torque tolerance +0%, -15% of torque values. Unless otherwise specified, use torque values listed above.

Parts

⚠ WARNING

This product can expose you to chemicals known to the State of California to cause cancer and birth defects or other reproductive harm.
For more information go to www.P65Warnings.ca.gov/product.

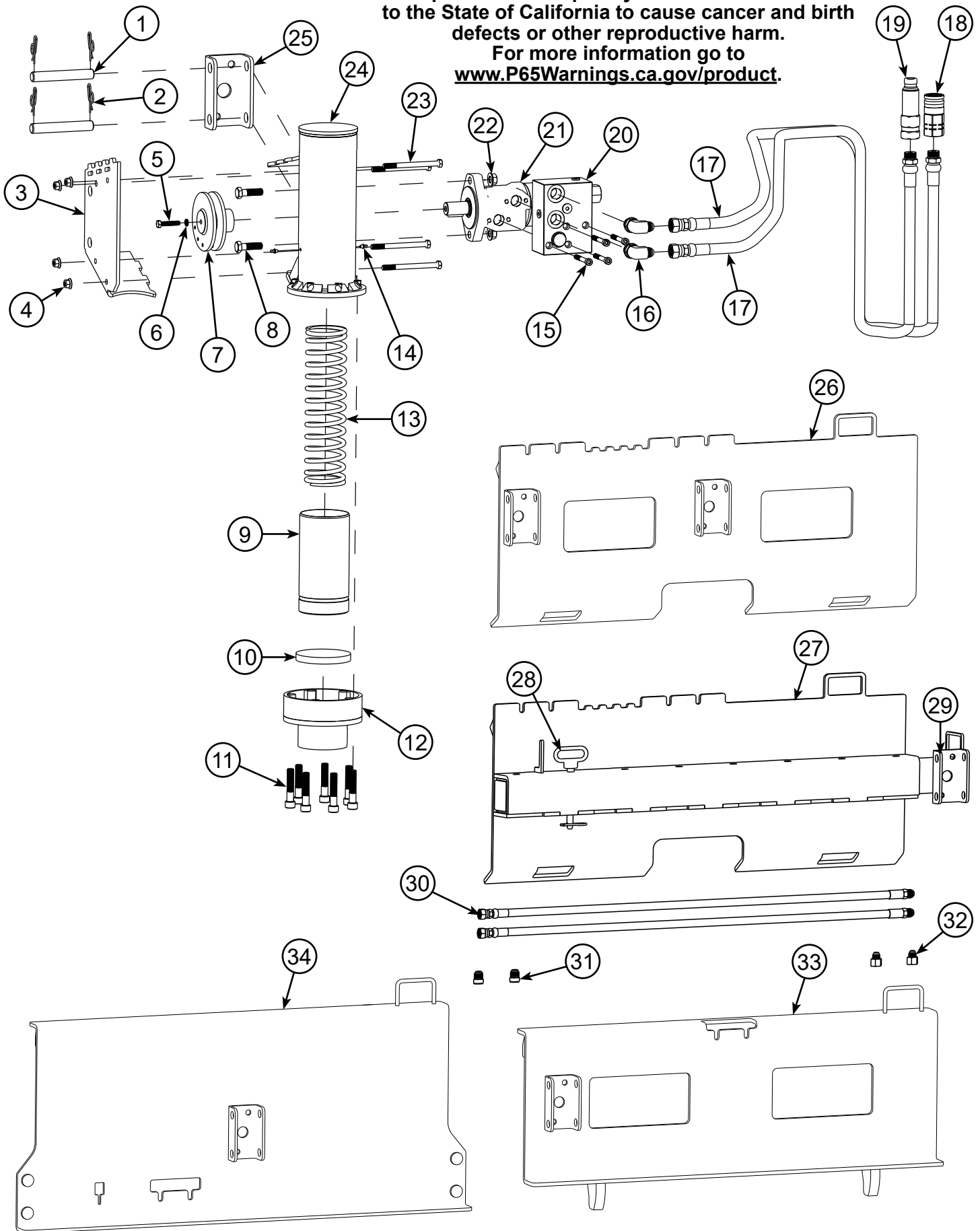

Parts

(continued)

REF. NO.	PART NO.	DESCRIPTION	QTY.
1	21284	Pin	2
2	21078	Rue Clip	4
3	21392	Cover Plate	1
4	21316	Toplock Flange Nut (3/8"-16)	4
5	21319	Hex Bolt (M8 x 1.25 x 40mm)	1
6	21376	5/16" Wedge Lock Washer	1
7	21380	Drive Wheel Assembly	1
8	933	Hex Cap Screw (1/2"-13 x 1-3/4", Gr. 5)	2
9	21296	Weight Assembly	1
10	21391	Strike Plate	1
11	21383	Socket Head Bolt (1/2"-20 x 2-1/2")	7
12	21388	Foot	1
13	21323	Compression Spring	1
14	35220	Grease Fitting	3
15	21379	Socket Head Cap Screw (M8 x 65mm)	4
16	20034	Elbow	2
17	21393	Hydraulic Hose Assembly	2
18	10049	Female Coupler	1
19	12108	Male Coupler	1
20	21378	Hydraulic Manifold	1
21	21377	Hydraulic Motor	1
	20079	Hydraulic Motor Seal Kit (Not Pictured)	
22	6196	Toplock Flange Nut (1/2"-13)	2
23	21318	Bolt (3/8"-16 x 4-1/2", Gr. 5)	4
24	21384	Housing	1
25	21302	Mount Bracket	1
26	21305	Skid-Steer Quick Attach Mount	1
27	21355	Skid-Steer Offset Quick Attach Mount	1
28	21366	Hitch Pin	1
29	21362	Arm Assembly	1
30	21367	Hydraulic Hose Extension	2
31	176000	Hose Adapter (#8 JIC F to #10 JIC M)	2
32	176001	Hose Adapter (#10 JIC F to #8 JIC M)	2
33	21303	Euro/Global Offset Quick Attach Mount	1
34	21304	John Deere 200/300/400/500 Series Quick Attach Mount	1

Tilt Bracket

PN 21301 - Tilt left or right up to 20°. T-Handle design with lockout feature. Hardware included. Works with all T3 Driver mount platforms.

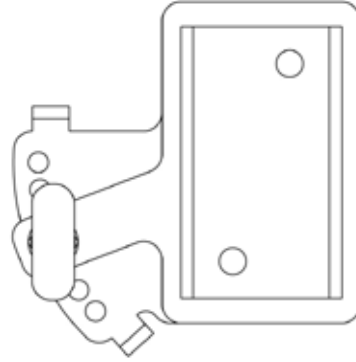

Mount Bracket

PN 21302 - Bolt-on/weld-on bracket that mounts to a flat surface. Hardware not included.

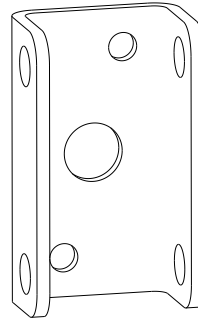

Plumb Bob

PN 21356 - Provides vertical line reference for operator.

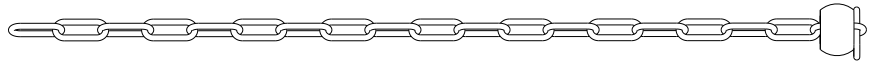
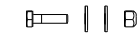

Front-End Loader Hose Kit

PN 21231 - 1/2" hose kit, 25' long, with flat face ISO couplers and pioneer couplers. Mounting bracket included for bolting or welding. Hardware not included.

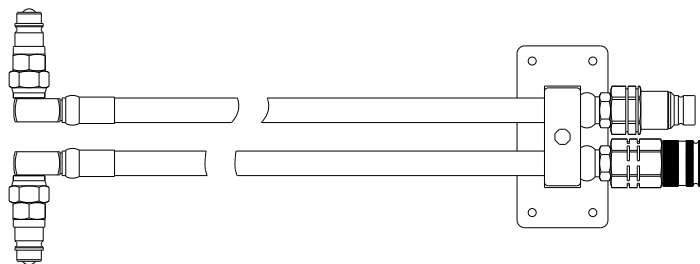

WARNING

This product can expose you to chemicals known to the State of California to cause cancer and birth defects or other reproductive harm. For more information go to www.P65Warnings.ca.gov/product.

This page is intentionally blank.

LIMITED WARRANTY

Danuser LLC ("Danuser") warrants its products, under normal use and maintenance, to be free from defects in material and workmanship for period(s) specified below from the purchase date from an authorized Danuser Dealer. Start of the warranty period is determined by purchase date given on your returned WARRANTY REGISTRATION FORM. Proof of purchase may be required. This Limited Warranty is extended only to the original purchaser of Danuser products.

T3 Driver - 1 Year

Wear Items Not Covered Under Warranty - Hydraulic Hoses and Seals

1. During the applicable warranty period, Danuser, at its option, will repair or replace any part determined by Danuser to be defective. Such repair or replacement shall take place at Danuser's factory or a location designated by Danuser. Under no circumstances shall Danuser be obligated for the cost of any repair or replacement by anyone other than Danuser without its express written consent.
2. Parts may not be returned without written authorization from Danuser.
3. Some purchased components, including but not limited to hydraulic components, are subject to the inspection and warranty of the respective manufacturer. Thus, delays in a warranty determination can be expected while Danuser awaits their decision.
4. This warranty is void if any attempt is made to make field repairs to hydraulic components. To qualify for warranty inspection, the "failed" part(s) must be returned in its original "failed" condition.
5. To make a claim under this warranty, first contact your authorized Danuser Dealer. The Danuser Dealer shall complete the Warranty Claim Form and obtain written authorization from Danuser to return parts. All warranty claims must include detailed information regarding make and model of vehicle on which the Danuser product was mounted, hours of use, description of events that led up to the failure, and any other information helpful in reviewing the warranty claim. All warranty returns must be prepaid. Shipments arriving at our factory on a freight collect basis will be refused by our receiving department. The freight charge will be credited if the parts are determined by Danuser to be defective, and the associated freight costs in returning those parts will be prepaid by Danuser. **NOTE:** Hydraulic components must arrive with all ports sealed from dirt and moisture. If a hydraulic component arrives with open ports, the warranty is void and no inspection will be made.
6. Products or parts thereof which, as determined by Danuser's examination, show wear from normal use, have been improperly operated, damaged by accident or negligence, field repaired, altered or modified are not considered defective in material and workmanship and are not covered by this warranty. This warranty does not apply to parts subject to normal wear ("Wear Items") or to damage caused by the failure to perform recommended maintenance or to replace worn parts. This warranty shall not obligate Danuser to bear any cost of labor for field repair, replacement, testing, or adjustment nor for damage caused by accident, abuse, misuse, or environmental elements.
7. Any parts or labor required to repair or replace parts not covered under this warranty will be charged to the customer. Parts repaired or replaced by Danuser are then covered by this warranty only for the remainder of the original warranty as if such parts were original parts.
8. Danuser reserves the right to change its specifications and designs at any time.

This warranty is exclusive and in lieu of all other express warranties, if any, including the implied warranties of merchantability and fitness for a particular purpose. It shall not extend beyond the duration of the expressed warranty provided herein and the remedy for violations of any implied warranty shall be limited to repair or replacement of the defective part pursuant to the terms contained herein. No employee, dealer, salesman, or representative is authorized to change this warranty in any way or grant any other warranty. Danuser shall not be liable for any consequential, incidental, or punitive damages, losses, or expenses, including those resulting from or caused by any defects.

Danuser LLC
500 E. 3rd St.
P.O. Box 368
Fulton, MO 65251

Tel: (573) 642-2246
Fax: (573) 642-2240
E-mail: sales@danuser.com
Website: www.danuser.com